

Bitte lassen Sie die Leuchten von einer autorisierten Elektrofachkraft montieren! Vor den Installationsarbeiten Netzspannung abschalten.

Lamps must be mounted by a skilled person! Before mounting disconnect mains voltage.

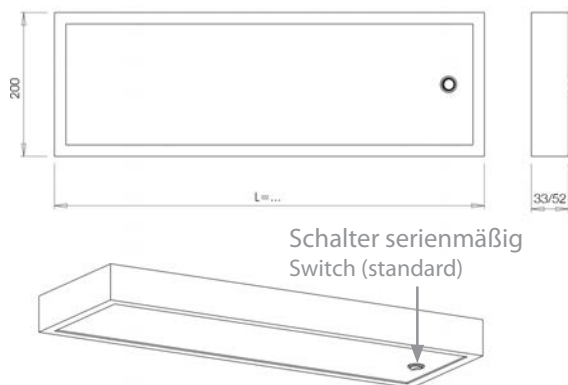

Montageanleitung

Assembly Instruction

(D) Spannung: 230-240V~ 50-60 Hz/12V Leistung: max. 28W Fassung: G5 Lampe: T5	(A)	(GB) Voltage: 230-240V~ 50-60 Hz/12V Power: max. 28W Fitting: G5 Bulb: T5	(IRL)	(F) Tension: 230-240V~ 50-60 Hz/12V Puissance: max. 28W Douille: G5 Ampoule: T5	(B)	(I) Tensione: 230-240V~ 50-60 Hz/12V Consumo: max. 28W Portalamпада: G5 Sorgente: T5 luminosa	(NL) Spanning: 230-240V~ 50-60 Hz/12V Vermogen: max. 28W Fitting: G5 Verlichtings-: T5 middel
(ES) Tensión: 230-240V~ 50-60 Hz/12V Potencia: max. 28W Portalampadas: G5 Lámpara: T5	(DK) Spænding: 230-240V~ 50-60 Hz/12V Ydelse: max. 28W Fattning: G5 Pære: T5	(SF) jännite: 230-240V~ 50-60 Hz/12V teho: max. 28W kanta: G5 lamppu: T5	(S) Spänning: 230-240V~ 50-60 Hz/12V Effekt: max. 28W Fattning: G5 Ljuskälla: T5	(P) Tensão: 230-240V~ 50-60 Hz/12V Potência: max. 28W Casquilho: G5 Lâmpada: T5	(GR) Τάση: 230-240V~ 50-60 Hz/12V Απόδοση: max. 28W Ντρουί: G5 Λάμπα: T5		

(D) (A) Garantie

Sie haben ein hochwertiges Produkt erworben, welches mit Sorgfalt produziert und verpackt wurde. Sollten Sie dennoch einmal Grund zur Beanstandung haben, wenden Sie sich bitte umgehend an Ihren Fachhändler. Bitte bewahren Sie für diesen Fall Ihren Kassenzettel und die Verpackung auf. Ihre Reklamation wird bei uns im Haus umgehend bearbeitet.

(GB) (IRL) Warranty

You have acquired a high-quality product that was manufactured and packed with care. If you nevertheless should have any reason for complaint, please approach your dealer immediately. Retain your receipt and the packaging, in case this is necessary. Your complaint will be dealt with immediately at your works.

(F) (B) Garantie

Vous venez d'acquérir un produit de qualité qui a été fabriqué et emballé avec soin. Si vous deviez toutefois avoir des raisons de vous plaindre, adressez-vous immédiatement à votre revendeur. Veuillez conserver votre ticket de caisse et l'emballage. Nous traiterons immédiatement votre réclamation.

(I) Garanzia

Avete acquistato un prodotto di elevato valore, realizzato e imballato con la massima cura. Se aveste comunque una lamentela, rivolgetevi subito al vostro rivenditore. In tal caso conservate lo scontrino e l'imballo. Provvederemo a risolvere subito il motivo del vostro reclamo.

(NL) Garantie

U heeft een hoogwaardig product gekocht dat zorgvuldig geproduceerd en verpakt werd. Indien u nochtans een reden tot klacht heeft gelieve zich dan onmiddellijk tot uw vakhandelaar te wenden. Bewaar voor dit geval uw kasticket en de verpakking. Uw klacht wordt onmiddellijk in onze firma behandeld.

(ES) Garantia

Ha adquirido un producto de alta calidad, producido y embalado con sumo cuidado. Sin embargo, si tuviera algún motivo de reclamación, póngase en contacto inmediatamente con su distribuidor. En este caso conserve su ticket de venta y el embalaje original. Nos ocuparemos de su reclamación inmediatamente.

(DK) Garanti

De har netop købt et kvalitetsprodukt, der er blevet produceret og pakket ind med stor omhu. Hvis De alligevel ønsker at reklamere produktet, bedes De sætte Dem i forbindelse med Deres lokale forhandler. Kassesejlen og emballagen skal opbevares i tilfælde af reklamation. Deres reklamation vil blive behandlet omgående.

(SF) Takuu

Olet hankkinut korkeatasoisen tuotteen, joka on huolella valmistettu ja pakattu. Jos kuitenkin löydät tuotteen valittamisen aiheutta, ota heti yhteys myyjäläikkeseen. Säilytä tätä varten ostokuitisi ja tavaran pakkauksen. Valituksesi käsitellään meillä välittömästi.

(S) Garanti

Du har köpt en kvalitetsprodukt som omsorgsfullt har producerats och förpackats. Om du ändå skulle ha invändningar bör du omgående ta kontakt med din leverantör. Bevara därför ditt kvitto och originalförpackningen. Din reklamation blir då omedelbart behandlad av oss.

(P) Garantia

Adquiriu um produto de primeira qualidade, fabricado e embalado cuidadosamente. Se, todavia, tiver alguma razão para reclamação, por favor contacte imediatamente o seu revendedor especializado. Conserve o seu talão da caixa para esse caso e a embalagem. A sua reclamação será tratada na nossa empresa imediatamente.

(GR) Εγγύηση

Έχετε αγοράσει ένα υψηλής ποιότητας προϊόν, το οποίο κατασκευάστηκε και συσκευάστηκε με προσοχή. Εφ' όσον ωστόσο έχετε λόγους διαμαρτυρίας, απευθυνθείτε άμεσα στον έμπορο που σας το προμήθευσε. Γι αυτή την περίπτωση παρακαλούμε κρατήστε την απόδειξη και τη συσκευασία. Η διαμαρτυρία σας θα ελεγχθεί άμεσα από την εταιρεία μας.

Top Light e.K.
Industriezentrum 100
D-32139 Spenge
GERMANY
www.top-light.de - brief@top-light.de



Lightboard
Sushi, Tokio

Tokio

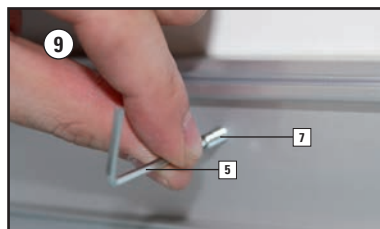
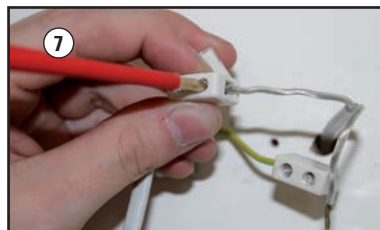
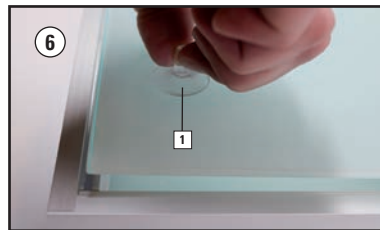
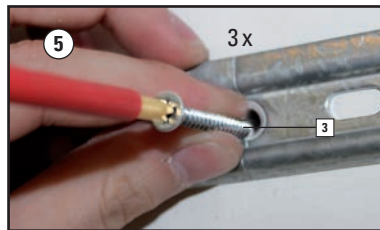
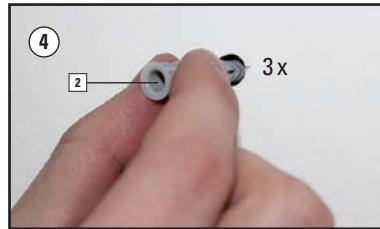
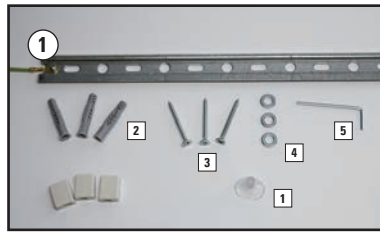

Sushi

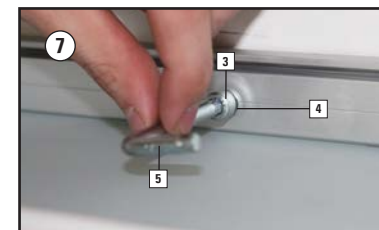
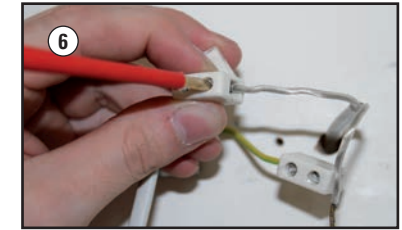
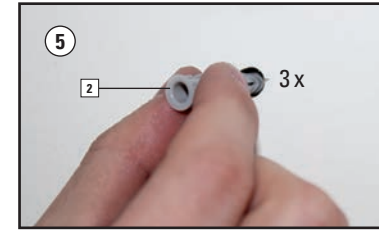
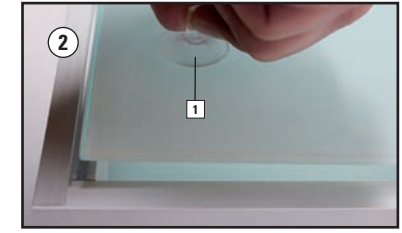
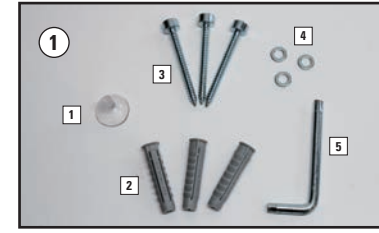

Sushi

Tokio